

Twin Pole Lite PURE LED

Cat. No. TPL/L

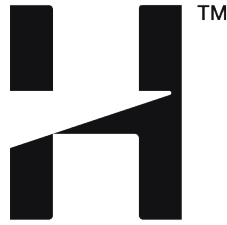

PURE LED
Pure Performance

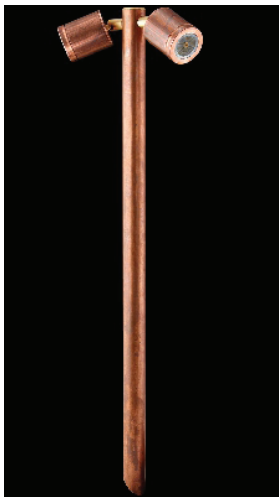
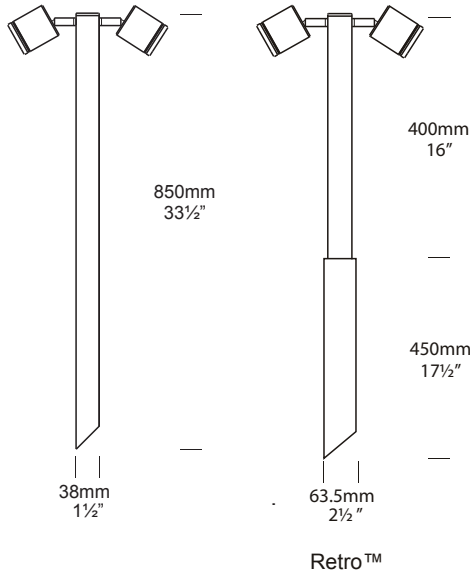

The Twin Pole Lite Pure LED is ideal for path lighting as well as tree lighting, or the heads may be aimed downward to eliminate vertical light. The fixture has two individual spotlights which can be aimed in two entirely different directions. Each lite has fully adjustable arms allowing 360 degree rotation and 0 - 90 degree elevation.

The Retro™, which is a mains option, avoids the need to bury a driver. The 110/240 volt electronic driver is built into the pole. This changes the luminaire to an IP56 rating.

The Hunza PURE LED system uses Cree MTG-2 chips for maximum performance and long life. Power supply options include a choice of integral 12 or 120 / 240 volt (Retro) drivers. There is also an external remote (series connection) driver option. The PURE LED system incorporates HUNZA's Plug-and-Play system for easy replacement of either the LED engine or integral driver in the field. Four beam angles, and a choice of a Warm or Cool White colour temperatures are available.

*At 700mA this fitting is the equivalent of a 35w halogen fitting.
*At 1050mA this fitting is the equivalent of a 50w halogen fitting.

Ordering Information

Luminaire	Drivers	Lens	ColourTemp	Accessories	Material/Finish
TPL/L	S - Series D7 - 12v 700mA D10 - 12v 1050mA RE - 240v 700mA RU - 110v 700mA	15 - 15° TIR Lens 25 - 25° TIR Lens 38 - 38° TIR Lens 60 - 60° TIR Lens	2 - 2700K 3 - 3000K 4 - 4000K	CJK150 - Cable Joint Kit LENSSTEPF - Frost Lens GG - Glare Guard HCL - Hex Cell Louvre Adaptor	BK - Black BZ - Bronze GN - Green STAR - Silver Star WH - White WB - Birch DG - Dark Grey OG - Olive Green RG - Beige PR - Primrose COP - Copper SS - 316 Stainless

Ordering Sample: TPL/LD7 60 4 GG COP

HUNZA™ PURE OUTDOOR LIGHTING

HUNZA FACTORY
130 Felton Mathew Ave
Glen Innes
Auckland 1072
New Zealand

Ph: 64-9-528 9471
Fax: 64-9-528 9361
hunza@hunza.co.nz
www.hunza.co.nz

INTERNATIONAL CONTACTS:
www.hunza.co.nz/contacts.php

Specifications may change without notice.
Manufactured in New Zealand.
© 2015 Hunza Holdings Ltd.

Luminaire Construction

CNC machined from one of the following metals:

Aluminium: High corrosion resistant 63.5mm (2½") x 10mm (25/64") aluminium. End cap - solid aluminium 63.5mm (2½") rod, with chromate substrate and high UV resistant polyester powder coat. **Colours** Black, White, Bronze, Green, Silver Star, White, Birch, Dark Green, Olive Green, Beige, Primrose.

Copper: 63.5mm (2½") x 10mm (13/32"). End cap - solid copper 63.5mm (2½") rod.

316 Stainless Steel: 9mm (11/32"). End cap - solid 316 stainless steel 63.5mm (2½") rod.

Poles: Aluminium, Copper, 316 Stainless 38mm (1½") x 850mm (33½") tube.

Retro™ 38mm (1½") x 410mm (16") tube.
Transformer Pole: 63.5mm (2½") x 440mm (17½").

Luminaire Weight

12 volt Alum 1.200kg (2lb 10oz)
Cop 3.500kg (7lb 7oz)
SS 2.800kg (6lb 2oz)

Retro™ Alum 2.300kg (5lb 1oz)
Cop 4.300kg (8lb 9oz)
SS 3.600kg (7lb 11oz)

Luminaire Features

Lens

7mm (¼") extra clear low iron flush fit shatter resistant glass. Lifetime Warranty.

Gasket: Silicone, iron impregnated 220°C (428°F)

Accessories:

Cable Joint Kit (Cat. CJK150)
Frosted Lens (Cat. LENSSTEPF).
Glare Guard (Cat. GG).
Hex Cell Louvre Adaptor (Cat. HCL).

Swivels:

Aluminium and Copper luminaires 3600 rotation and 0 - 900 elevation, solid brass with anti rust spring.

Stainless Steel luminaires 3600 rotation and 0 - 900 elevation, full stainless steel construction.

Mounting

Pole 850mm (33½") directly mounted into the earth. Retro™ set in concrete.

Technical Information

Standards

IP56/IP66 UL183

LED (per head)

Cree MTG-2 Plug and Play, field replaceable LED board.

Lumen Output: 510 at 1050mA

Lumens Per watt: 85 at 6watts

CRI Warm White (3000k): 85+

Colour Temp: 2700K, 3000K and 4000K

Power Supply

Series (External) Driver

Constant current driver

Output: 6vdc at 1050mA maximum

Integral 12 Volt Driver

Hunza™ Plug and Play Driver

Input: 12vac, 7 watt total

Output: 6vdc nominal, 350 / 700 / 1050mA

Transformer

Hunza™ Wall Mount Transformer for use with integral 12 volt driver

Retro 110/240 Volt Driver

Hunza™ Retro Driver

Input: 120/240vac, 5 watt total

Output: 6vdc, 700mA

0-10 volt dimming

(USA - non dimming)

Reflector Beam Angles

TIR Lens

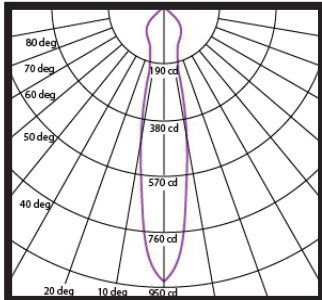

15° Angle
3000 K

TIR Lens

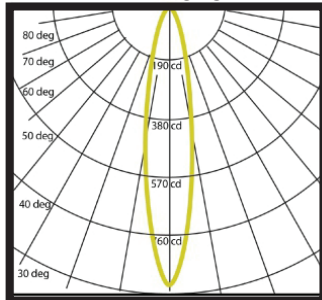

25° Angle
3000 K

Machined Reflector

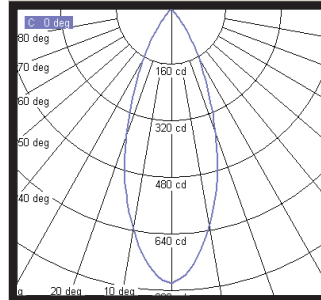

38° Angle
3000 K

Machined Reflector

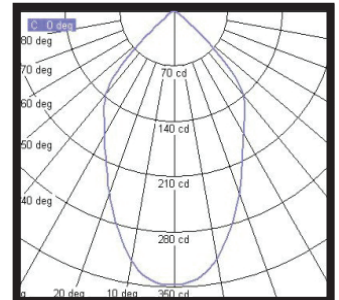

60° Angle
3000 K

HUNZA™ PURE
OUTDOOR
LIGHTING

HUNZA FACTORY
130 Felton Mathew Ave
Glen Innes
Auckland 1072
New Zealand

Ph: 64-9-528 9471
Fax: 64-9-528 9361
hunza@hunza.co.nz
www.hunza.co.nz

INTERNATIONAL CONTACTS:
www.hunza.co.nz/contacts.php

Specifications may change without notice.
Manufactured in New Zealand.
© 2015 Hunza Holdings Ltd.